

anti-flooding valve Stausafe H, DN 150

Part number: 661197
 GTIN: 4001636661197
 Rebate group: 3

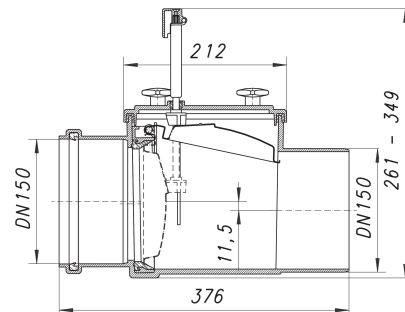

Description:

anti-flooding valve Stausafe H, DN 150
 for use with rain water systems

specification:

- self-closing stainless steel flap
- manually operated lock
- stainless steel pivots
- easy to maintain ABS housing
- inspection cover with wingnuts can be opened for maintenance without tools

Dimensions of Dallmer anti-flooding valves on page XXX.

Spare parts:

664020 wing nuts for Stausafe (4 pieces), M 8

664082 grab for Stausafe H and RS, DN 150/ DN

664044 cover seal for Stausafe DN 150/DN 200